



SigmaNEST



## The World's Most Advanced CAD/CAM Nesting Software

### ✚ Machines and Motion at their Best

SigmaNEST advanced nesting solution offers a wide range of customizable, modular features to get the most out of your manufacturing operations. Using SigmaNEST, you can import parts from any major CAD system, automatically sort them into tasks by material and machine, optimize your material usage and machine motion, post programs to your profile cutting machines, and track your productivity from start to finish.

### ✚ Designed to Help Fabricators Win

SigmaNEST drives nearly every type of profile cutting, routing, or punching machine to produce premium quality parts while saving valuable material and manpower. CAD integration, an intuitive interface, and local customer support, are all reasons why SigmaNEST is the industry leader with over 21,000 systems installed worldwide.

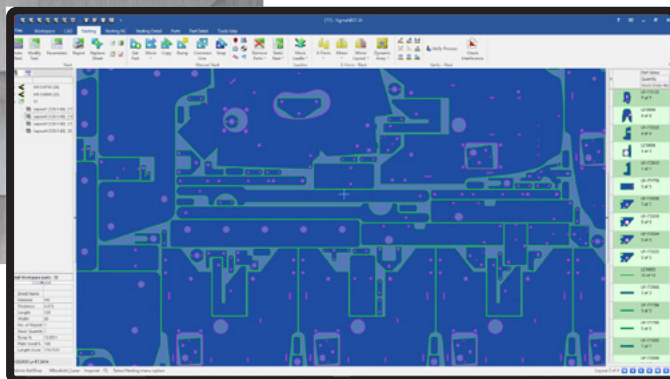

#### Machines Supported:

- Laser
- Plasma
- Oxyfuel
- Punch
- Combo
- Waterjet
- Router
- Knife
- Multi-process
- Multi Axis

# Helping Fabricators Win

SigmaNEST software is engineered to optimize the whole fabrication process and your business profitability



CAD/CAM Nesting



Shop Floor Control



Business Integration

## Efficiency and Savings

SigmaNEST impacts the full range of fabrication workflow, from quoting to production to shipping. This comprehensive approach results in ROI by optimizing material utilization, machine motion, manpower, and data management.



### Material

Smart nesting saves 4% average on new and remnant use



### Motion

Faster cutting times to increase capacity and efficiency



### Machines

Central control gives you more flexibility and simplicity



### Manage

Greater insight and control of operations through shared data



### Manpower

Faster programming and automation to empower your team

# Nesting Perfected

Use less material through higher nest yield—most customers save more than 4% on material when switching to SigmaNEST

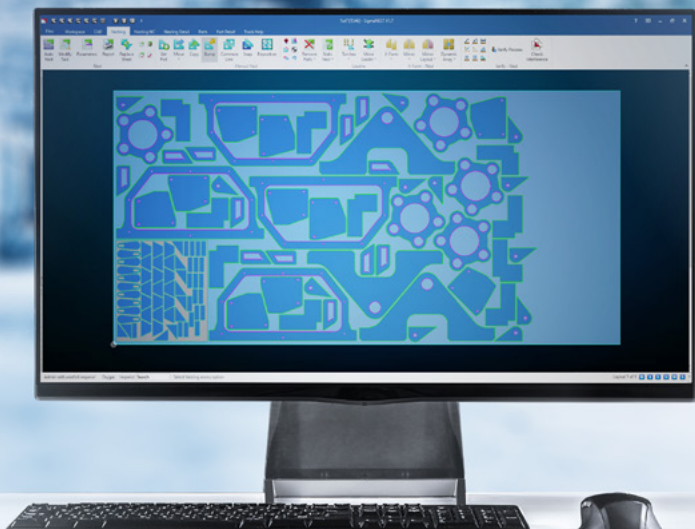

## Intelligent Nesting

- Advanced algorithms optimize material savings with using part rotation, mirroring, and more
- Nesting strategies for complex machines account for hold downs, clamps, repositioning, bevel cutting, and secondary processes
- Effortlessly nest parts for specialized operations and materials like right angle shear, drop door part ejection, and common line cutting
- Automated choices for best sheet size and sheet priority

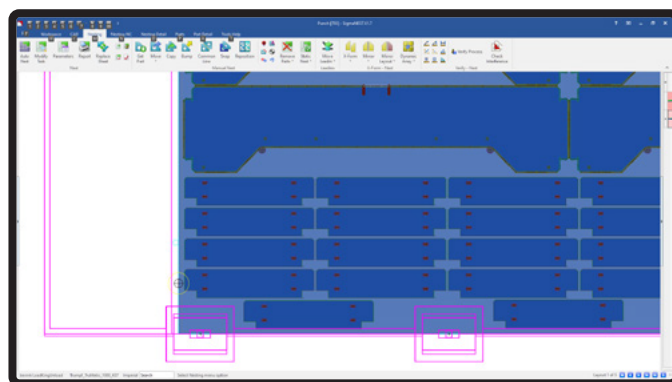

Intelligent nesting around machine clamps

## Powerful Inventory Management

- Remnant Nesting promotes a First-In First-Out approach to help maintain lean inventory
- Track inventory status and cost through integrated stock and remnant material database
- Real-time sheet and heat number tracking
- Bi-directional data exchange with existing ERP/ MRP systems to ensure accurate sheet quantities
- Easily identify customer consigned sheets or reserved inventory
- Readily search sheet, part, and work order lists

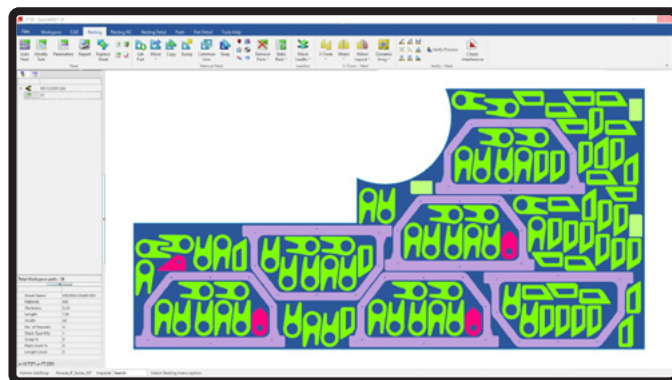

Maximize material use with remnant nesting

# Versatile CAD Import

Smart time-saving CAD import recognizes 2D parts or 3D assemblies, and automatically calculates part cost and cutting time

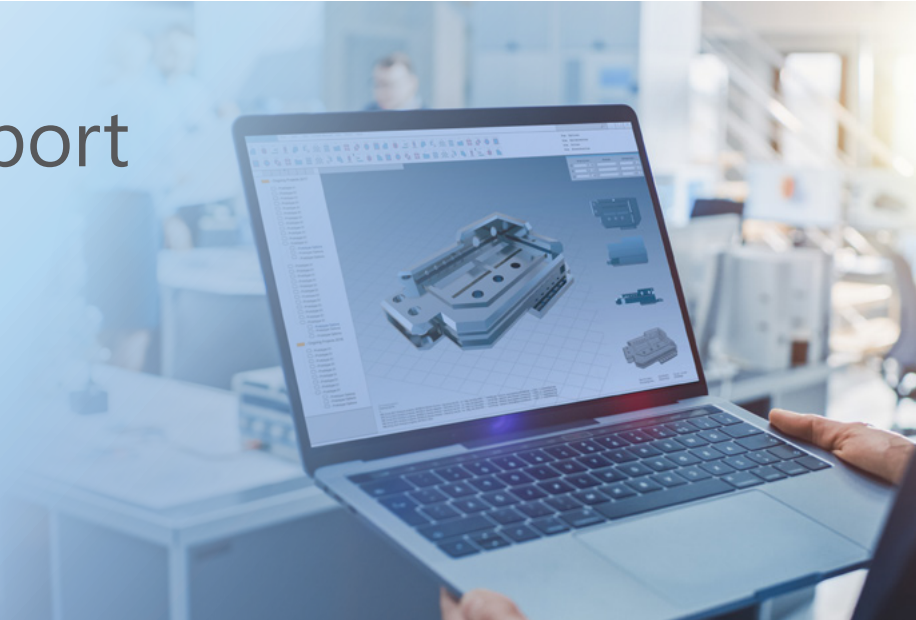

## 🇨🇦 Diverse CAD Import

- Directly import any major 2D and 3D file for painless part creation
- Leverage filters and mapping tools to only bring in the parts you need
- Recognize important CAM features on the drawing or model like bevels, milling pockets, and bends
- Automatic error correction for DXF, DWG, CDL, IGES, DSTV, STEP files, G-code and NC ESSI code

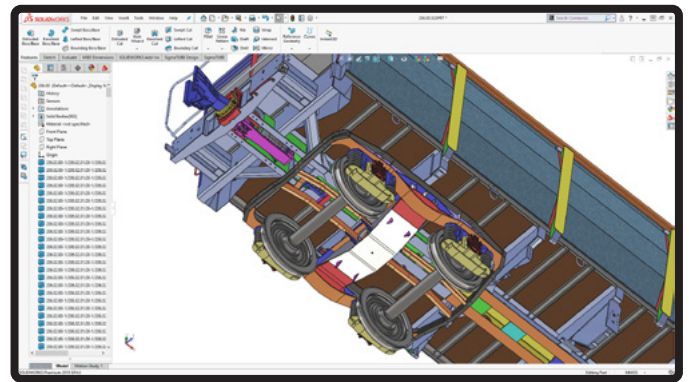

Directly import any major file format

## 🇨🇦 Part Creation and Version Management

- Fast geometry creation with easy CAD tools, standard shapes library, user-definable scripting, dimensioning, and part data marking
- Store part, nest layout, toolpath, and machine data in an intelligent workspace file
- Integrated parts database keeps a searchable catalog of all parts, and part geometry, material, area, weight, and cost

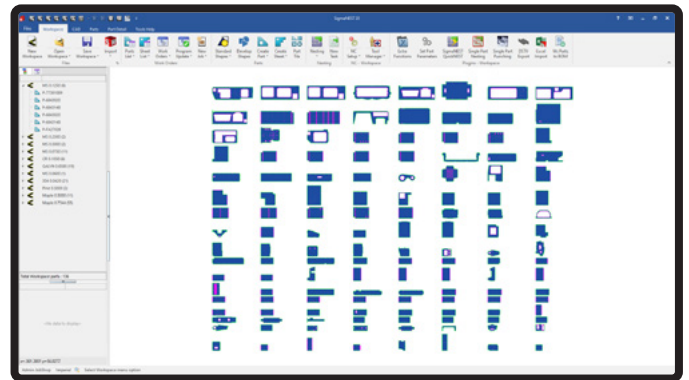

Quickly create a workspace with parts

## 🇨🇦 Automatic Part Cost Estimating

- Automatically calculate part area, weight, cutting time, cost, and material requirements on import
- User-definable reports and cost parameters



# Business Accelerated

Streamline business with instant quoting, automated work orders and BOMs, job tracking, scheduling and integrated production data

## Easy Job Handling

- Batch processing of Bill of Material (BOM) files
- Track status of each part for every order
- Dynamically load multiple orders for just-in-time nesting and cutting

## Job Tracking and Scheduling

- Automatic part quantity tracking and production scheduling
- Work order status reporting
- Explicit control for holding and releasing orders and parts for production
- Integrated order database

## Detailed Reporting

- Dozens of pre-built report templates for different business areas like costing, inventory, machine operations, and unloading
- Easy-to-use editor to customize any report
- SigmaNEST reporting data can be imported, exported, or connected to nearly any system

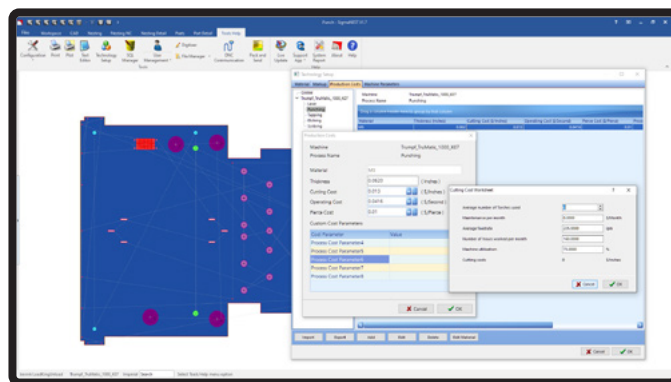

Save part details for better costing

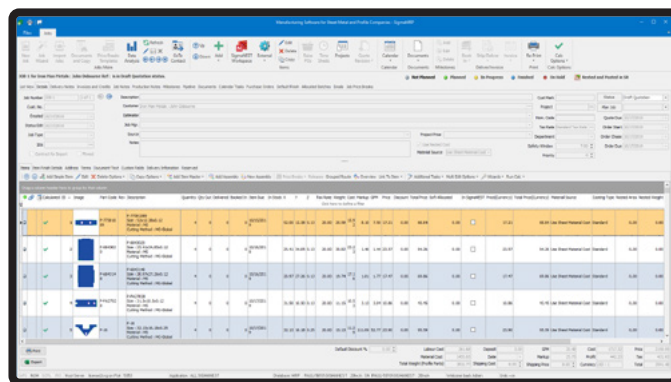

Full job view for fast and accurate quoting

# Advanced Motion

One programming software for all simple and complex machines – including punch, profile, and combination



## ✚ Sophisticated Toolpath Strategies

- State-of-the-art machine motion options reduce cutting time, consumable usage, and tool wear
- Optimum default settings for machine, material, and thickness simplify programming choices and reduce trial and error
- Increase machine performance with improved sequencing, scrap stability analysis, machine bed slat detection, and more

## ✚ Advanced NC Profiling

- 3D modeling for accurate bevel programming to ensure part quality
- Recess tabs to eliminate grinding, automatic center-of-gravity tabs to avoid tipping
- Common line cutting, bridge cutting, and chain cutting reduce cut distance, z-axis head movement, and pierce quantity
- Pre-Pierce using secondary processes such as drill and punch to limit consumable wear and improve quality
- BHQ bolt hole quality for plasma cutting
- Automatic crop cut and scrap cut for safe processing and removal of excess material

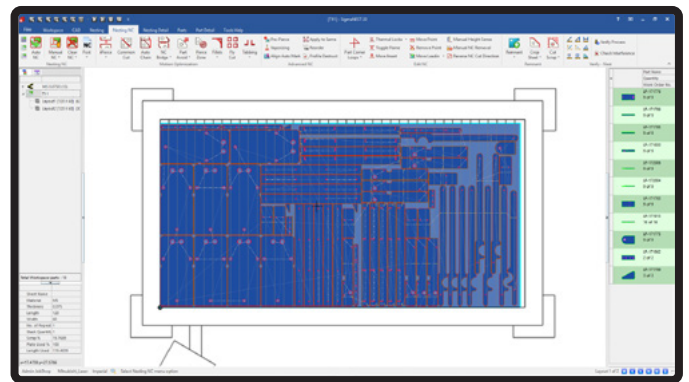

Intelligent tool paths optimized for specific machines

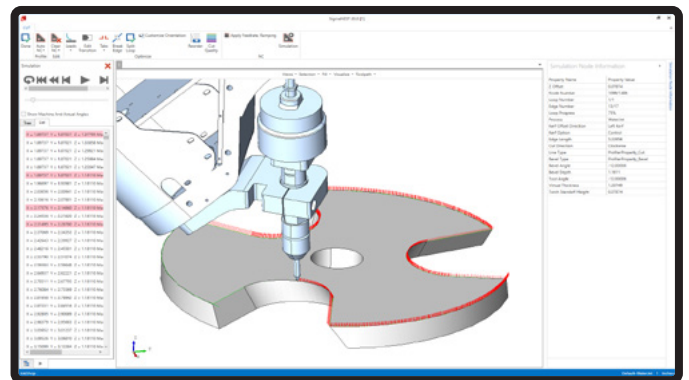

3D modeling ensures accurate bevel cutting



# For Any Machine

SigmaNEST empowers you to operate your shop, your way by letting you select the solution you need

## + Punch and Combination

- Comprehensive nesting with powerful sequencing provides ultimate control of laser/punch combination machines
- Formed feature protection saves forms by reorganizing the nearby hits on parts
- Stored pattern punching automatically punches production parts consistently

## + Waterjet Cutting

- Advanced programming optimizes feed and flow rate for superior part quality and maximum cutting speed

## + Router and Drilling

- Advanced router and drilling solutions with automatic recognition of complex 3D models for safe and easy toolpath application

## + Knife and Composites

- Fully-featured CNC knife cutting technology supports composite materials and overcut control

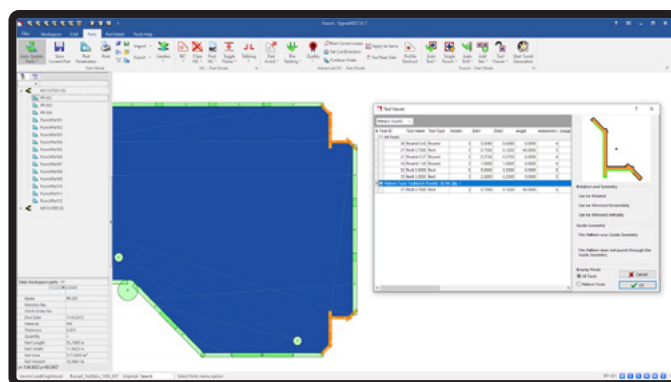

Punch detail with user-defined tool

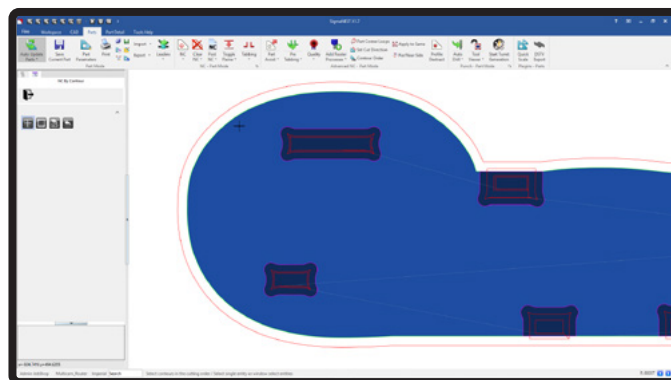

Router partial depth pocketing



# Sharing Data

Link the right data at the right time throughout your operations for better insight and smoother operations

## + Better CAD/CAM Integration

- Full integration and automatic part creation with 2D and 3D CAD systems including SolidWorks Enterprise PDM
- Smart inventory management with stock control and remnant tracking
- Complete part quoting, cost estimation, and searchable part database

## + Better Shop Floor Control

- Better shop floor execution with Color Offload, Load Manager and Shop Floor Data Capture
- Advanced solutions for greater automation from shop floor optimization

## + Better Business Management

- Connects with ERP/MRP business systems for cost control and profitability
- SimTrans data manager creates a continuous link between manufacturing processes and business operations
- Total integration with SigmaMRP for streamlined costing, planning, and tracking

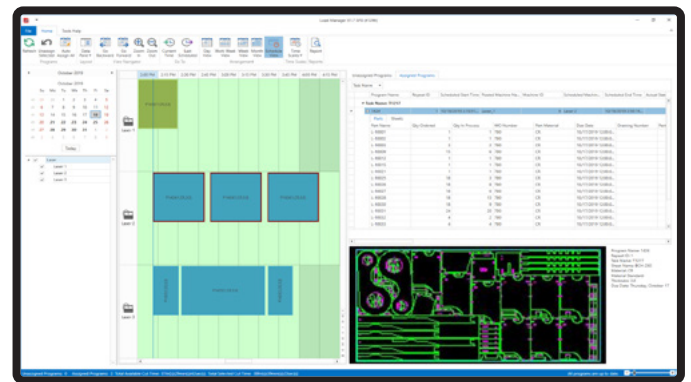

Shop floor integration for smoother operation

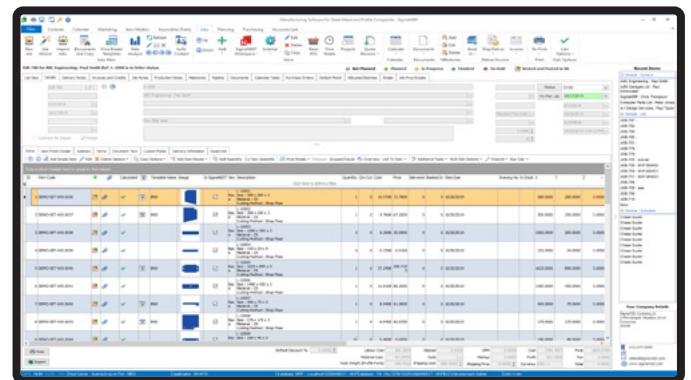

SigmaMRP integration for business insight